

OWNER'S MANUAL

Assembly & Operating Instructions



PORTABLE CONCRETE VIBRATOR

VIB35P.V24



Thank you for choosing our Equipment. It was carefully engineered to provide excellent performance when properly operated and maintained.

Please read this entire manual before operating the Equipment. It instructs you on how to set up, operate, and maintain your Equipment safely and easily. Ensure that you and any other persons operating the Equipment carefully follow the recommended safety practices at all times, as failure to do so could result in personal injury or property damage.

All information in this manual is relevant to the most recent product information available at the time of printing. Review this manual frequently to familiarize yourself with the machine, its features, and operation. Please note that this Owner's Manual may cover a range of product specifications for various models. Characteristics and features discussed and/or illustrated in this manual may not be applicable to all models. We reserve the right to change product specifications, designs, and equipment without notice and without incurring obligation.

All the power testing information used to establish the power rating of the engine equipped on this Equipment can be found in the engine manufacturer's manual or website. If you encounter any problems or have questions about the machine, please contact our Customer Support Department.

Throughout this manual, all references to the right and left side of the Equipment are observed from the operating position. The engine manufacturer is responsible for all engine-related issues concerning performance, power-rating, specifications, warranty, and service. Refer to the engine manufacturer's Owner's Manual, packed separately with your Equipment, for more information.

Customer Support

Before initiating a product return, kindly reach out to our dedicated Customer Support Department at Bigger Boyz Toyz. We are here to assist you.

Phone: 02 4257 4787

Email: bbt@bbta.com.au

Warehouse: Unit 2/3 Delta Place, Albion Park Rail NSW 2527

If you have difficulty assembling the product or have any questions about the controls, operations, or maintenance of the equipment, please don't hesitate to get in touch with our Customer Support Department.

CONTENTS

SAFETY & ALERT SYMBOLS	4
FOR YOUR SAFETY AND THE SAFETY OF <u>OTHERS!</u>	4
ADDITIONAL INFORMATION AND POTENTIAL CHANGES	4
HAZARDS SYMBOLS	5
GENERAL SAFETY	6
TRANSPORTING	7
MAINTENANCE.....	7
EMERGENCIES.....	7
MECHANICAL HAZARDS.....	7
NOISE HAZARDS	7
ADDITIONAL HAZARDS.....	7
GENERAL INFORMATION.....	8
APPLICATION.....	8
FUNCTION AND CONTROLS.....	8
ASSEMBLY	8
OPERATION.....	9
SERVICE & STORAGE.....	10
SERVICE.....	10
CLEANING AND STORAGE.....	10
MAINTENANCE	10
SPECIFICATION	11
REPLACEMENT PARTS LIST.....	12

SAFETY & ALERT SYMBOLS

FOR YOUR SAFETY AND THE SAFETY OF OTHERS!



Safety precautions should be followed all the time when operating this equipment. Failure to read and understand the Safety Messages and Operating Instructions could result in injury to yourself and others



This Operating Instructions has been developed to provide complete instructions for the safe and efficient operation of this equipment. Refer to the engine manufactures instructions for data relative to its safe operation.



WARNING: Read and thoroughly understand all instructions in this equipment and on the safety decals before assembling or operating this equipment. Failure to do so may cause serious injury or death. Do not allow anyone to operate this equipment who has not read this manual. As with all power equipment, this equipment can be dangerous if assembled or used improperly. Do not operate this equipment if you have any questions concerning its safe operation. Contact our Customer Support Department for assistance in addressing any queries or concerns.

This SAFETY ALERT SYMBOL identifies important safety messages in this manual. Failure to follow this important safety information may result in serious injury or death.



DANGER indicates a hazardous situation which, if not avoided, will result in serious injury or death.



WARNING indicates a hazardous situation which, if not avoided, could result in serious injury or death.



CAUTION indicates a hazardous situation which, if not avoided, could result in minor or moderate injury.

ADDITIONAL INFORMATION AND POTENTIAL CHANGES













We reserve the right to discontinue, change, and improve our products at any time without notice or obligation to the purchaser. The descriptions and sections contained in this manual were in effect at the time of printing. Equipment described within this manual may be optional. Some illustrations may not be applicable to your machine.



Your Responsibility—Restrict the use of this power machine to persons who have read, understood, and will follow the warnings and instructions in this manual and on the machine
SAVE THESE INSTRUCTIONS!

HAZARDS SYMBOLS

Potential hazards associated with the operation of this equipment will be referenced with Hazard Symbols which appear throughout this manual.

	READ THE OWNER'S MANUAL(S) : Read, understand and follow all instructions in the manual(s) before attempting to assemble and operate.
	FACE PROTECTION : Always wear safety goggles or safety glasses with side shields or a face shield when operating this product as well as ear protection.
	WEAR GLOVES : Always wear non-slip, heavy-duty protective gloves when operating this product.
	WEAR SAFETY FOOTWEAR : Always wear non-slip steel-toed safety footwear when operating this product.
	BEWARE OF ROTATING BLADES : This equipment has a rotating cutting blade capable of amputating hands and feet and throwing objects. Keep hands and feet out of openings while machine is running. Failure to observe these safety instructions could result in serious injury or death.
	BEWARE OF FLYING OBJECTS : Beware of thrown objects, which can ricochet causing serious injury to the eyes. Always wear eye & ear protection when operating.
	Never wear loose clothes or long jewellery and keep your long hair secured when operating machine. Never operate this machine in bare feet or sandals. Never use machine on a slope or hard smooth floor.
	CARBON MONOXIDE AND GAS : Exhaust contains poisonous carbon monoxide, a colourless and odourless gas. Breathing exhaust fumes can cause loss of consciousness and may lead to death.
	RESPIRATORY HAZARDS : ALWAYS wear approved respiratory protection when required.
	PETROL OIL : Petrol is extremely flammable and the vapours are explosive. Serious personal injury can occur when petrol is spilled on you or your clothing, which can ignite. In the event of a petrol spill, wash your skin and change clothes immediately.
	BURN HAZARDS : Engine components can produce intense heat. To avoid burns, DO NOT touch these areas while the engine is running or right after operations. Never operate the engine with removed heat shields or guards.
	DO NOT use in the rain.
	ACCIDENTAL STARTING HAZARDS : Always place the ON/OFF switch in the OFF position when the equipment is not in use.

GENERAL SAFETY

- » DO NOT operate or service this equipment before reading this entire manual.
- » This equipment should not be operated by persons under 18 years of age.
- » NEVER operate this equipment without proper protective clothing, shatterproof glasses, steel-toed boots, and other protective devices required for the job.
- » NEVER operate this equipment when not feeling well due to fatigue, illness, or taking medicine.
- » NEVER operate this equipment under the influence of drugs or alcohol.
- » ALWAYS wear proper respiratory (mask), hearing, and eye protection equipment when operating the equipment.
- » Whenever necessary, replace the nameplate, operation, and safety decals when they become difficult to read.
- » The manufacturer does not assume responsibility for any accidents due to equipment modifications.
- » NEVER use accessories or attachments that are not recommended for this equipment. Damage to the equipment and/or injury to the user may result.
- » NEVER touch the hot exhaust manifold, muffler, or cylinder. Allow these parts to cool before servicing the engine or equipment.
- » High Temperatures – Allow the engine to cool before adding fuel or performing service and maintenance functions. Contact with hot components can cause serious burns.
- » The engine section of this equipment requires an adequate free flow of cooling air. NEVER operate the equipment in any enclosed or narrow area where the free flow of air is restricted; it will cause serious damage to the equipment or engine and may cause injury to people.
- » ALWAYS refuel in a well-ventilated area, away from sparks and open flames.
- » ALWAYS use extreme caution when working with flammable liquids. When refuelling, stop the engine and allow it to cool.
- » NEVER operate the equipment in an explosive atmosphere or near combustible materials. An explosion or fire could result, causing severe bodily harm or even death.
- » DO NOT smoke around or near the machine. Fire or explosion could result from fuel vapours, or if fuel is spilled on a hot engine.
- » Topping-off to the filter port is dangerous, as it tends to spill fuel.
- » Stop the engine when leaving the equipment unattended.
- » Maintain this equipment in a safe operating condition at all times.
- » ALWAYS stop the engine before servicing, adding fuel and oil.
- » NEVER run the engine without an air filter. Severe engine damage may occur.
- » ALWAYS service the air cleaner frequently to prevent carburetor malfunctions.
- » ALWAYS check the machine for loosened threads or bolts before starting.
- » ALWAYS ensure the operator is familiar with proper safety precautions and operational techniques before using the equipment.
- » ALWAYS store equipment properly when it is not being used. Equipment should be stored in a clean, dry location out of the reach of children.
- » DO NOT operate this equipment unless all guards and safety devices are attached and in place.
- » CAUTION must be exercised while servicing this equipment.
- » Keep all inexperienced and unauthorized people away from the equipment at all times.

- » Unauthorized equipment modifications will void all warranties.
- » NEVER pour or spray water over the engine.
- » Test the engine ON/OFF switch before operating. The purpose of this switch is to shut down the engine of the equipment.
- » Refer to the Engine User's Manual for engine technical questions or information recommended for the equipment.

TRANSPORTING

- » ALWAYS shut down the engine before transporting.
- » Tighten the fuel tank cap securely and close the fuel cock to prevent fuel from spilling.
- » Drain fuel when transporting the equipment over long distances or bad roads.
- » When placing the equipment inside a truck bed for transport, always tie down the equipment.

MAINTENANCE

- » NEVER lubricate components or attempt service on a running equipment.
- » ALWAYS allow the equipment a proper amount of time to cool before servicing.
- » Keep the equipment in proper running condition.
- » Fix damage to the equipment immediately and always replace broken parts.
- » Dispose of hazardous waste properly. Examples of potentially hazardous waste are used motor oil, fuel, and fuel filters.
- » DO NOT use wooden or plastic containers to dispose of hazardous waste.

EMERGENCIES

- » ALWAYS know the location of the nearest fire extinguisher and first aid kit.
- » In emergencies, always know the location of the nearest phone or keep a phone on the job site. Also, know the phone numbers of the nearest ambulance, doctor, and

fire department. This information will be invaluable in the case of an emergency.

MECHANICAL HAZARDS

- » DO NOT operate the machine unless all protective guards are in place.
- » Before removing guards or making adjustments, ensure that the motor operation switch is in the OFF position and that the spark plug ignition lead is disconnected.
- » Exercise caution when handling vibrators, as prolonged exposure to vibration or repetitive work actions may be harmful to hands and arms.
- » Do not hold the vibrator shaft in your hands while it is running. Instead, hold the vibrator by the "D" handle and use the supplied carry strap to help isolate your hands from the vibration.
- » Never stand on the vibrating head while it is operating. Additionally, do not place your foot on the vibrator head while it is running unless it is done momentarily and the vibrator head is resting on a resilient support such as a car tire.

NOISE HAZARDS

- » Excessive noise can lead to temporary or permanent loss of hearing.
- » Wear an approved hearing protection device to limit noise exposure as required by Occupational Health and Safety regulations.
- » Engines and vibrators may produce noise levels in excess of 85dB(A).

ADDITIONAL HAZARDS

- » To reduce the risk of injury from loss of balance, start the motor with the unit on a flat, level surface, and only pick up the unit when the engine is idling.
- » Slip, trip, and fall incidents are a major cause of serious injury or death. Be cautious of the flexible shaft and water left on the walking or work surface.

GENERAL INFORMATION

APPLICATION

The portable concrete vibrator finds applications in a wide range of sectors:

- » Civil projects: roadways, kerbing, precast beams, bridge decks, and piers.
- » Commercial building tasks: strip and raft foundations, stairs, walls, floors, driveways, suspended slabs, tilt panels, and stack-cast panels.
- » Residential building endeavors: floor stumps, wall cavities, house slabs, wall footings, and paving slabs.
- » Rural projects: fence posts, stock troughs, and pens.

FUNCTION AND CONTROLS

DRIVE UNIT:

The portable drive unit is specifically designed to power flexshaft drive and eccentric vibrators.

- » **Motor control:** An ON/OFF push button, mounted below the throttle lever on the handle, regulates the motor.
- » **Speed control:** The motor speed is managed by a throttle lever located on the handle.
- » **Centrifugal clutch:** Fitted to the motor, this clutch disengages the drive to the vibrator when the motor is idling. It operates automatically and requires no adjustment.
- » **Fuel type:** The motor is a 4-stroke unit and must only be operated with unleaded petrol.

VIBRATOR:

The vibrator is intended for compacting concrete by immersing the vibrator head. This process enhances the strength and finish of concrete by eliminating entrapped air.

- » High frequency vibration enables efficient compaction of low slump concrete mixes.
- » **Drive mechanism:** The vibrator head is propelled by a rotating flexible drive shaft

that transmits the drive from the drive unit.

- » **Vibration generation:** An eccentric mass within the vibrator head produces vibration, with ball bearings supporting the rotor at each end.

ASSEMBLY

If the unit was supplied unassembled, the following steps must be completed before operation:

1. Begin by connecting the flexible shaft to the motor unit. Position the threaded ferrule end of the flexible shaft approximately 20 mm from the coupling housing. Insert the squared end of the flexible shaft core assembly into the squared seal sleeve adaptor.
2. Screw the threaded ferrule end of the flexible shaft into the motor adaptor. Rotate the ferrule end in an anti-clockwise direction to engage the left-hand thread.
3. After hand-tightening, use multigrip pliers to ensure the ferrule is securely tightened to prevent it from loosening during operation.
4. The unit comes with a 1-liter container of Honda 10W/30 engine oil. The engine oil capacity is 100 ml. Place the unit on a level surface and remove the oil filler cap. Add oil until the level reaches the edge of the oil filler neck, then reinstall the oil filler cap.
5. Fuel can now be added, and the unit is ready for operation.

OPERATION

1. To start the motor, first, place the unit on a flat, level surface, and only pick it up when the engine is idling.
2. Then, turn the engine switch to the ON position.

Note:

- » For a cold engine, move the choke lever to the closed position before starting.
- » If restarting a warm engine, leave the choke lever in the OPEN position.

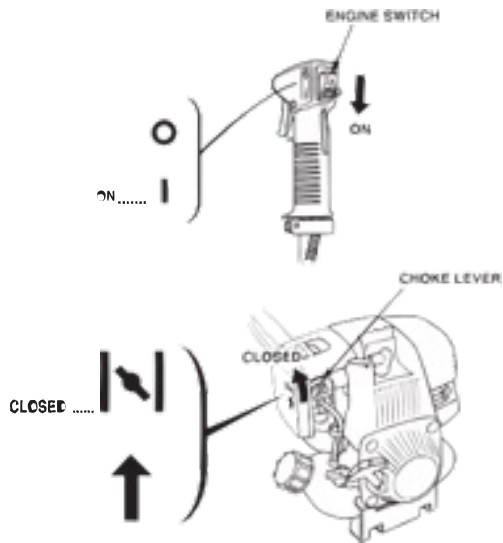

3. Next, press the priming pump several times until fuel flow is visually noticed in the fuel return tube.
4. Hold the unit steady and pull the starter grip lightly until you feel resistance, then pull briskly. Gently return the starter grip after pulling.

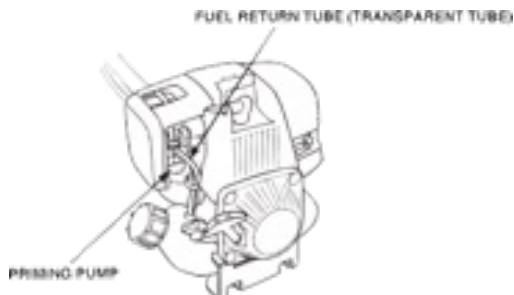

5. As the engine warms up, gradually move the choke lever from the CLOSED to the OPEN position if it was initially closed.
6. The idle-up function aids engine starting by moderately opening the throttle valve in the carburetor when the engine won't start:

1. Hold down the throttle interlock.
2. Pull the throttle trigger.
3. Push the idle-knob, then release the throttle trigger and the interlock.
4. Start the engine.

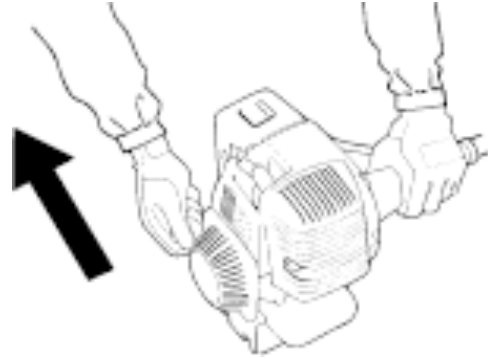

NOTE:

- » Do not engage the idle-up function while vibrating.
- » Ensure the unit operates at full throttle at all times to achieve proper concrete compaction and prevent damage to the drive mechanism.
- » Exercise caution when starting or revving the unit on loose gravel to prevent gravel from being drawn into the flywheel cooling fins, potentially damaging the unit.
- » Refer to the FLEXTOOL FACT SHEET for information on concrete compaction using immersion vibrators.
- » Avoid sharp bends in the flexshaft, especially during operation.
- » Do not use an eccentric-type immersion vibrator head externally by applying it to the outside of formwork.
- » Avoid operating the vibrating head out of concrete for extended periods. Do not let it run while waiting for fresh supplies of concrete, as vibrator heads rely on being cooled by the concrete in which they are immersed.

SERVICE & STORAGE

SERVICE

- » Regularly replace the oil in the motor crankcase with Honda 10W/30 oil.
- » Service the air cleaner element by washing it in a non-flammable solvent, drying thoroughly, soaking it in clean engine oil, squeezing out excess oil, and reinstalling.
- » Clean the fuel tank strainer regularly to prevent poor engine performance.
- » Inspect, clean, and/or replace the spark plug on a regular basis.

CLEANING AND STORAGE

- » Wash the vibrator head and flexshaft with clean water after each use and before storage to prevent concrete accumulation.
- » Ensure the cooling fins on the motor remain unobstructed.

MAINTENANCE

- » Keep the unit clean and free of concrete residue.
- » Check the oil level in the engine crankcase daily, ensuring it reaches the edge of the oil filler neck.
- » Handle vibrators with care and conduct regular maintenance to prevent breakdowns.
- » Monitor the flexshaft and vibrator head for signs of wear and promptly rectify any faults.
- » Regularly inspect the flexible shaft for kinks and external damage.
- » Check the outer casing rubber cover for damage near the vibrator head.
- » Avoid operating the vibrator unchecked to prevent concrete from entering components.
- » Use caution when retrieving a vibrator trapped in concrete reinforcing bars to avoid damage to the rubber cover.

SPECIFICATION

MOTOR	Honda, 35 cc 4-stroke petrol
MOTOR OIL CAPACITY	100 ml
MODEL	BBT-CNSV
TYPE	Hard Nose
PART NO.	F03330
FREQUENCY	9,000
AMPLITUDE	2.8 mm
HEAD DIA.	38 mm
WEIGHT	11 kg

REPLACEMENT PARTS LIST

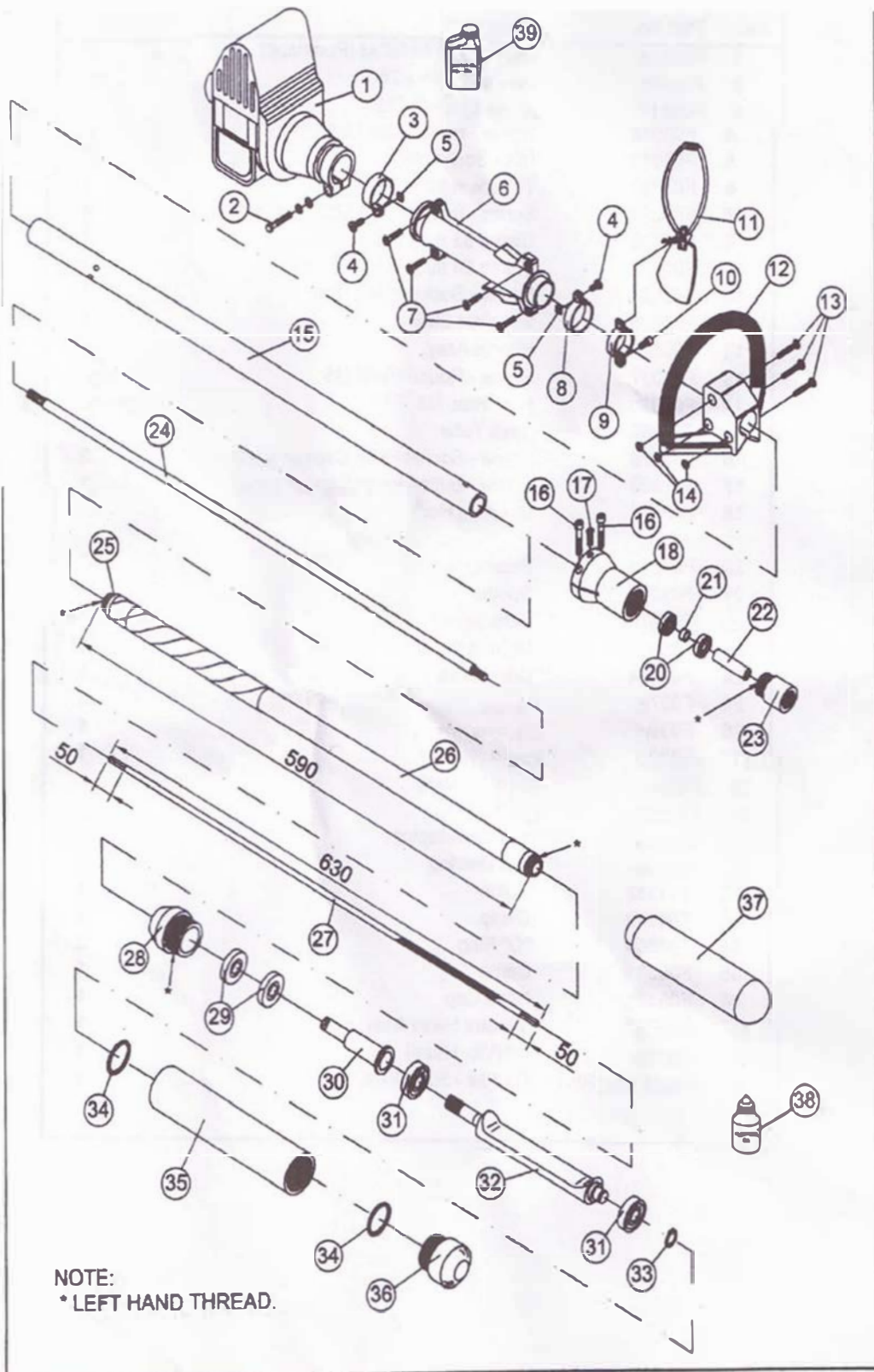

PART NO.	DESCRIPTION	QYT
F03318	Motor - Honda GX35 (Portable)	1
F03016	Bolt - Hex M6 x 28	1
F03017	Clamp 43mm Dia.	1
F03018	Screw - Round Head M6	2
F03019	Nut - Square M6	2
F03020	Throttle Handle Assy.	1
F03021	Screw - Self Tapping 5/32" Dia. X 5/8"	4
F03022	Clamp 33mm Dia.	1
F03023	Clamp 26mm Dia.	1
F03024	Screw - Socket Head Cap	1
F03025	Shoulder Strap	1
F03026	Handle Assy.	1
F03027	Screw - Round Head M5	3
F03028	Nut - Hex. M5	3
F03333	Drive Tube	1
F05876	Screw - Socket Head Cap 1/4" BSW.	2
F02986	Screw - Button Head Cap 1/4" BSW.	1
F02982	Coupling Housing	1

PART NO.	DESCRIPTION	QYT
F01515	Bearing	2
F03281	Spacer	1
F08870	Seal Sleeve	1
F05359	Motor Adaptor	1
F03334	Drive Shaft	1
F08783	Ferrule	2
F03001	Casing Assy.	1
F03002	Core Assy.	1
F09329	Seal Housing	1
F07508	Oil Seal	2
F06609	Spindle Adaptor	1
F09330	Ball Bearing	2
F09332	Rotor	1
F04180	Circlip	1
F04850	"O" Ring	2
F09331	Barrel	1
F09333	Nose Cap	1
F09328	Vibrator Head Assy.	1
F06700	Oil (Vib. Head)	1
H1002-P08-001	Oil 10w - 30w HONDA	1



BIGGER BOYZ TOYZ
COMMERCIAL

BBTA.COM.AU

Copyright © Bigger Boyz Toyz Australia

Unit 2/3 Delta Place Albion Park Rail NSW 2527 • 02 4257 4787

